

Wall mounted socket - Part no. 1145A

- screw terminals
- with SoftCONTACT
- suitable for through wiring
- internal fixing
- enclosure base can be turned 180°
- with 6 fixing points to accommodate special terminals
- products with pilot contacts on request

Protection type	IP 44
Ampere	63 A
Poles	5p
Voltage	400
Hertz	50-60Hz
Earth position	6h
Contact	standard
Connection technology	Screw terminals

Std. Pack. 5 Qty.

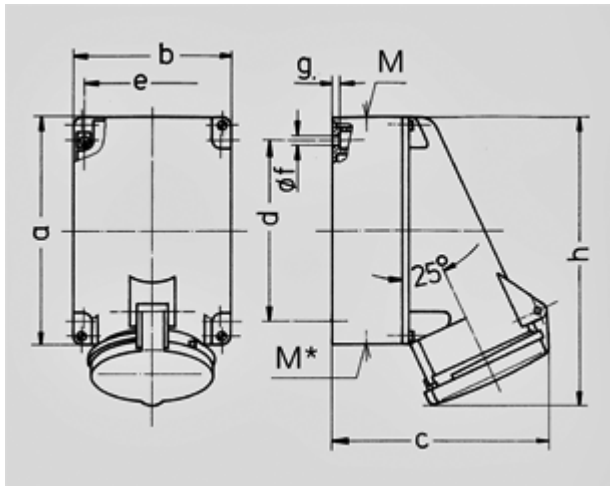

Drawing	Amp.	63		
		Poles		
1 MB 213		3	4	5
Dim. in mm	a	170	170	170
	b	118	118	118
	c	164	164	164
	d	134,5	134,5	134,5
	e	103	103	103
	f	6,1	6,1	6,1
	g	6	6	6
	h	216	216	216
	M	40	40	40
	M*	2xM40 (blind) to be cut out		
	Max. cable diam. (mm)	32	32	32
	Terminal for cond. cross section (mm ²) min.-max.	6	6	6
		-25	-25	-25